

EUROPE

GB Products with electronic ballasts / drivers must not be installed on the same electrical circuits as products with inductive loads, for example magnetic fluorescent luminaires, motors or ventilators. Inductive loads can generate excessive voltage surges which can damage electronic ballasts.

The light source in this luminaire shall only be replaced by the manufacturer or his service agent or a similar qualified person.

PLEASE READ THE INSTRUCTIONS CAREFULLY
BEFORE COMMENCING ASSEMBLY

Live: Normally Brown / Red
Neutral: Normally Blue / Black

This product contains a light source of energy efficiency class F to Regulation (EU) No 2019/2015 (01/09/2021)

FR Les luminaires utilisant un ballast électronique / drivers ne peuvent être installés sur le même circuit que des appareils avec charges inductives, tels que luminaires fluorescents magnétiques, moteurs et ventilateurs. Les charges inductives peuvent générer des voltages excessifs et ainsi endommager les ballasts électroniques.

La source lumineuse de ce luminaire devrait seulement être remplacée par le fabricant ou par un de ses agents de maintenance ou par une personne qualifiée similaire.

LIRE ATTENTIVEMENT LES INSTRUCTIONS
AVANT DE COMMENCER LE MONTAGE

Phase: Normalement Brun / Rouge
Neutre: Normalement Bleu / Noir

Ce produit contient une source lumineuse de classe d'efficacité énergétique F selon le règlement (UE) n° 2019/2015 (01/09/2021)

IT Tutti i prodotti che includono ballast elettronici / driver non devono essere installati sugli stessi circuiti elettrici come anche prodotti con carichi induttivi quali lampadari a fluorescenza magnetica, motori o ventilatori. I carichi induttivi possono generare scariche eccessive che possono danneggiare i ballast.

La sorgente di luce in questo apparecchio può essere sostituita solo dal produttore o da un suo agente di servizio o da una persona qualificata simile.

LEGGERE ATTENTAMENTE LE ISTRUZIONI
PRIMA DI COMINCIARE L'ASSEMBLAGGIO

Cavo positivo: normalmente marrone o rosso
Cavo neutro: normalmente blu o nero

Questo prodotto contiene una sorgente luminosa di classe di efficienza energetica F secondo il regolamento (UE) n° 2019/2015 (01/09/2021)

DE Produkte mit elektronischen Vorschaltgeräten/ Treibern dürfen nicht im selben Stromkreislauf installiert werden wie Verbraucher mit induktiven Lasten, z.B. magnetische Leuchtstofflampen, Motoren oder Ventilatoren. Induktive Lasten können übermäßige Spannungsspitzen erzeugen, die elektronische Vorschaltgeräte beschädigen könnten.

Die Lichtquelle in dieser Leuchte darf nur vom Hersteller oder seinem Servicemitarbeiter oder einer ähnlich qualifizierten Person ausgetauscht werden.

LESEN SIE BITTE DIE ANWEISUNGEN
SORGFÄLTIG DURCH, BEVOR SIE MIT DEM
ZUSAMMENBAUEN BEGINNEN

Phase: Normalerweise Braun / Rot
Nulleiter: Normalerweise Blau / Schwarz

Dieses Produkt enthält eine Lichtquelle der Energieeffizienzklasse X gemäß Verordnung (EU) Nr. 2019/2015 (01/09/2021)

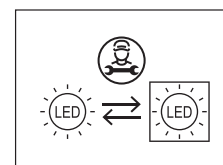

EN PLEASE READ THE INSTRUCTIONS CAREFULLY

PRODUCTS WITH ELECTRONIC BALLASTS/DRIVERS MUST NOT BE INSTALLED ON THE SAME ELECTRICAL CIRCUITS AS PRODUCTS WITH INDUCTIVE LOADS, FOR EXAMPLE MAGNETIC FLUORESCENT LUMINAIRES, MOTORS OR VENTILATORS. INDUCTIVE LOADS CAN GENERATE EXCESSIVE VOLTAGE SURGES WHICH CAN DAMAGE ELECTRONIC BALLASTS.

THIS PRODUCT MUST BE INSTALLED IN ACCORDANCE WITH THE APPLICABLE INSTALLATION CODE BY A PERSON FAMILIAR WITH THE CONSTRUCTION AND OPERATION OF THE PRODUCT AND THE HAZARDS INVOLVED CONSULT A QUALIFIED ELECTRICIAN TO ENSURE CORRECT BRANCH CIRCUIT CONDUCTOR.

FR LIRE ATTENTIVEMENT LES INSTRUCTIONS AVANT DE COMMENCER LE MONTAGE

LES LUMINAIRES UTILISANT UN BALLAST ÉLECTRONIQUE/DRIVERS NE PEUVENT ÊTRE INSTALLÉS SUR LE MÊME CIRCUIT QUE DES APPAREILS AVEC CHARGES INDUCTIVES, TELS QUE LUMINAIRES FLUORESCENTS MAGNÉTIQUES, MOTEURS ET VENTILATEURS. LES CHARGES INDUCTIVES PEUVENT GÉNÉRER DES VOLTAGES EXCESSIFS ET AINSI ENDOMMAGER LES BALLASTS ÉLECTRONIQUES.

CE PRODUIT DOIT ÊTRE INSTALLÉ SELON LE CODE D'INSTALLATION PERTINENT, PAR UNE PERSONNE QUI CONNAÎT BIEN LE PRODUIT ET SON FONCTIONNEMENT AINSI QUE LES RISQUES INHÉRENTS CONSULTER UN ÉLECTRICIEN QUALIFIÉ POUR VOUS ASSURER QUE LES CONDUCTEURS DE LA DÉRIVATION SONT ADÉQUATS.

ES LEA DETENIDAMENTE LAS INSTRUCCIONES

LOS PRODUCTOS CON REACTANCIAS ELECTRÓNICAS NO DEBEN SER INSTALADOS EN LOS MISMOS CIRCUITOS ELÉCTRICOS QUE LOS PRODUCTOS CON CARGA INDUCTIVA COMO, POR EJEMPLO, LUMINARIAS DE FLUORESCENTES MAGNÉTICOS, MOTORES O VENTILADORES. LA CARGA INDUCTIVA PUEDE GENERAR SOBREVOLTAJES EXCESIVOS QUE PODRIAN DAÑAR LAS REACTANCIAS ELECTRÓNICAS.









ESTE PRODUCTOR DEBE SER INSTALADO SEGUN EL CODIGO DE INSTALACION APLICABLE POR UNA PERSONA QUE CONOZCA LE CONSTUSSION Y EL FUNCIONAMIENTO DEL PRODUCTO Y LOS RIESGOS QUE SUPONE. CONSULTAR A UN ELECTRICISTA CALIFICADO PARA ASEGURAR LA ELECCION DEL CONDUCTOR DE CIRCUITO DERIVADO.

THIS DEVICE COMPLIES WITH PART 15 OF THE FCC RULES. OPERATION IS SUBJECT TO THE FOLLOWING TWO CONDITIONS:
 (1) THIS DEVICE MAY NOT CAUSE HARMFUL INTERFERENCE, AND (2) THIS DEVICE MUST ACCEPT ANY INTERFERENCE RECEIVED, INCLUDING INTERFERENCE THAT MAY CAUSE UNDESIRE OPERATION

NOTE: THIS EQUIPMENT HAS BEEN TESTED AND FOUND TO COMPLY WITH THE LIMITS FOR A CLASS B DIGITAL DEVICE, PURSUANT TO PART 15 OF THE FCC RULES. THESE LIMITS ARE DESIGNED TO PROVIDE REASONABLE PROTECTION AGAINST HARMFUL INTERFERENCE IN A RESIDENTIAL INSTALLATION. THIS EQUIPMENT GENERATES, USES AND CAN RADIATE RADIO FREQUENCY ENERGY AND, IF NOT INSTALLED AND USED IN ACCORDANCE WITH THE INSTRUCTIONS, MAY CAUSE HARMFUL INTERFERENCE TO RADIO COMMUNICATIONS. HOWEVER, THERE IS NO GUARANTEE THAT INTERFERENCE WILL NOT OCCUR IN A PARTICULAR INSTALLATION. IF THIS EQUIPMENT DOES CAUSE HARMFUL INTERFERENCE TO RADIO OR TELEVISION RECEPTION, WHICH CAN BE DETERMINED BY TURNING THE EQUIPMENT OFF AND ON, THE USER IS ENCOURAGED TO TRY TO CORRECT THE INTERFERENCE BY ONE OR MORE OF THE FOLLOWING MEASURES:

- REORIENT OR RELOCATE THE RECEIVING ANTENNA.
- INCREASE THE SEPARATION BETWEEN THE EQUIPMENT AND RECEIVER.
- CONNECT THE EQUIPMENT INTO AN OUTLET ON A CIRCUIT DIFFERENT FROM THAT TO WHICH THE RECEIVER IS CONNECTED.
- CONSULT THE DEALER OR AN EXPERIENCED RADIO/TV TECHNICIAN FOR HELP. CHANGES OR MODIFICATIONS NOT EXPRESSLY APPROVED BY THE PARTY RESPONSIBLE FOR COMPLIANCE COULD VOID THE USER'S AUTHORITY TO OPERATE THE EQUIPMENT.

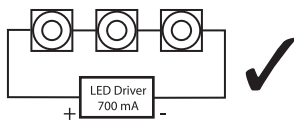
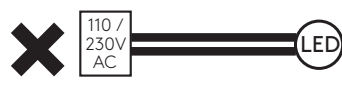
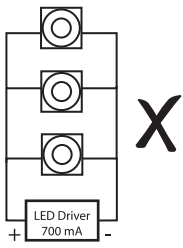
CAN ICES-005 (B) / NMB-005 (B)

	 DO NOT CONNECT LED DIRECTLY TO MAINS SUPPLY. DRIVER MUST BE USED.  Ne pas brancher les LED directement sur le secteur. Uniquement via driver.  Non collegare direttamente alla corrente. Utilizzare il driver.  Die LED darf nicht direkt an 230V angeschlossen werden. Hierzu wird ein Konverter benötigt.  No conecte un LED directamente a la red eléctrica. Deberá utilizar el conductor.	
		
	<p>PLEASE REFER TO THE "LED DRIVERS" GUIDE. Reportez-vous au document "LED Drivers". Si prega di riferirsi alla guida dei "Driver LED". Beziehen sich auf die "LED Drivers"-Dokument. Por favor consulte la guía de "Conductores LED".</p>	

1

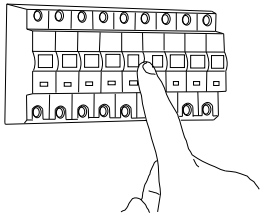

TURN OFF POWER
 Couper Le Courant! /
 Spegner La Corrente! /
 Strom Abshalten! /
 Corte La Corriente!

2

Borgo 55

Borgo 90

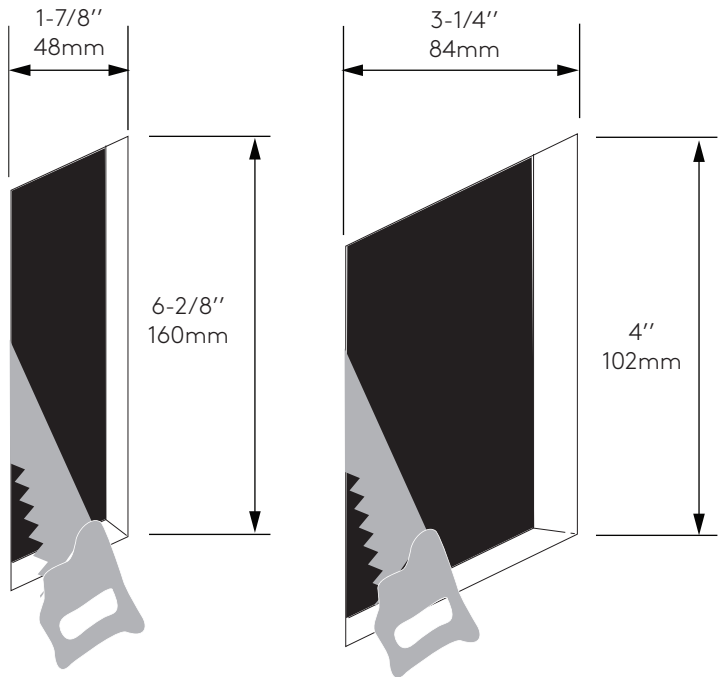

3

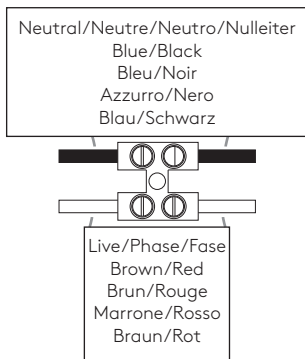

4

