

Volver, Breath of new *Light*

design Studio 14
terzani.com





TERZANI
LA LUCE PENSATA



Type |
Suspension

Materials |
Brass chains and metal
structure plated as below

Finishes | Code

-  Nickel
OL61S E7 C8
-  Black Nickel
OL61S E9 C8
-  Bronze
OL61S F7 C8
-  Gold
OL61S L6 C8

Body |

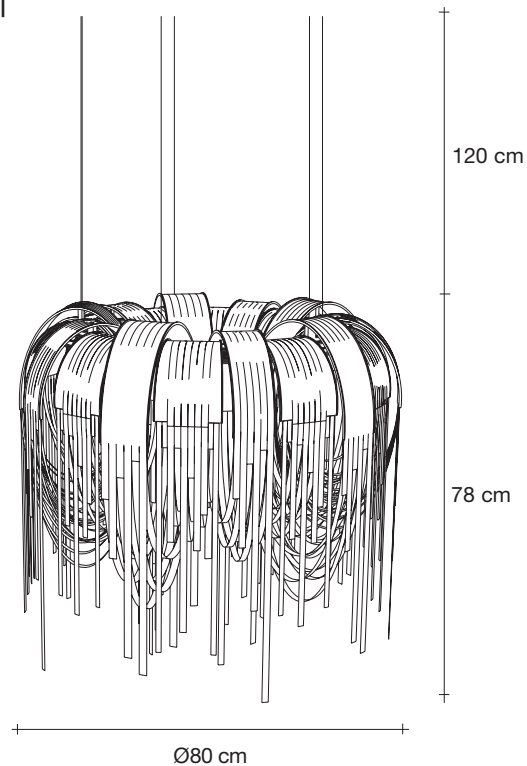

Integrated Led |
230-240V ~ 50/60Hz

 LED integrated
10 x 4,5W 5300 lm 3000K
or optional 2700K

 Dimmable with 1-10V
Dali system on request

Canopy |

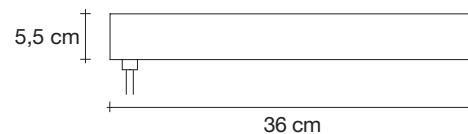

Designer Diego Bassetti and Architect Andrea Panzieri of Studio 14, protégés of Bruno Rainaldi, applied their multidisciplinary approach to create Terzani's first LED suspension light. This geometric design combines thin nickel chains with the latest in LED technology to create a light that is both elegant and modern. A breath of new light, Volver melds technology and art to achieve a new level of luxury.

