

# TARO FIRE RESISTANT

astro

GB

PLEASE READ THE INSTRUCTIONS CAREFULLY  
BEFORE COMMENCING ASSEMBLY

Live: Normally Brown / Red  
Neutral: Normally Blue / Black  
Earth: Normally Green / Yellow

FR

LIRE ATTENTIVEMENT LES INSTRUCTIONS  
AVANT DE COMMENCER LE MONTAGE

Phase: Normalement Brun / Rouge  
Neutre: Normalement Bleu / Noir  
Terre: Normalement Vert / Jaune

IT

LEGGERE ATTENTAMENTE LE ISTRUZIONI  
PRIMA DI COMINCIARE L'ASSEMBLAGGIO

Cavo positivo: normalmente marrone o rosso  
Cavo neutro: normalmente blu o nero  
Cavo terra: normalmente verde o giallo

DE

LESEN SIE BITTE DIE ANWEISUNGEN  
SORGFALTIG DURCH, BEVOR SIE MIT DEM  
ZUSAMMENBAUEN BEGINNEN

Phase: Normalerweise Braun / Rot  
Nulleiter: Normalerweise Blau / Schwarz  
Erde: Normalerweise Grün / Gelb



NOT SUITABLE FOR MOUNTING IN FLAMMABLE  
MATERIALS, E.G. WOOD.

Ne convient pas pour montage dans des matériaux inflammables.  
Non adatto ad essere montato in materiali infiammabili (per esempio legno).  
Nicht geeignet für eine Installation auf brennbaren Materialien, wie z.B. Holz.

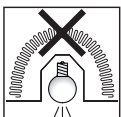

NOT SUITABLE FOR COVERING WITH THERMAL INSULATION.

Ne peut être recouvert de matériaux d'isolation.  
Non adatto ad essere coperto da isolanti termici.  
Nicht für die Abdeckung mit Wärmedämmung geeignet.



FOR CEILING USE ONLY

Seulement pour montage au plafond  
Da utilizzarsi solo al soffitto  
Nur für den Deckengebrauch

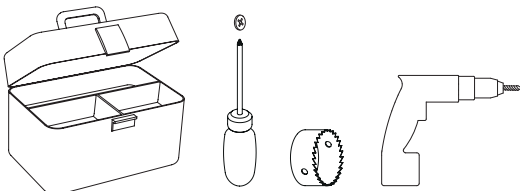

1

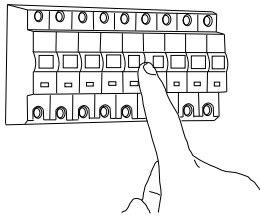

### TURN OFF POWER

Couper Le Courant! / Spegnere La Corrente! /  
Strom Abhalten!

2

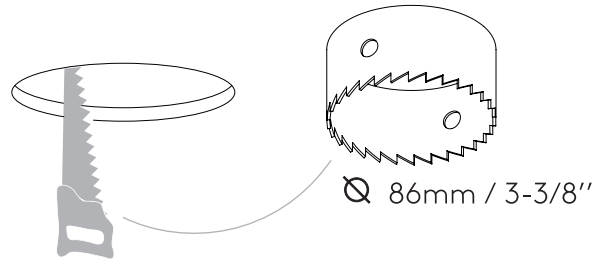

3

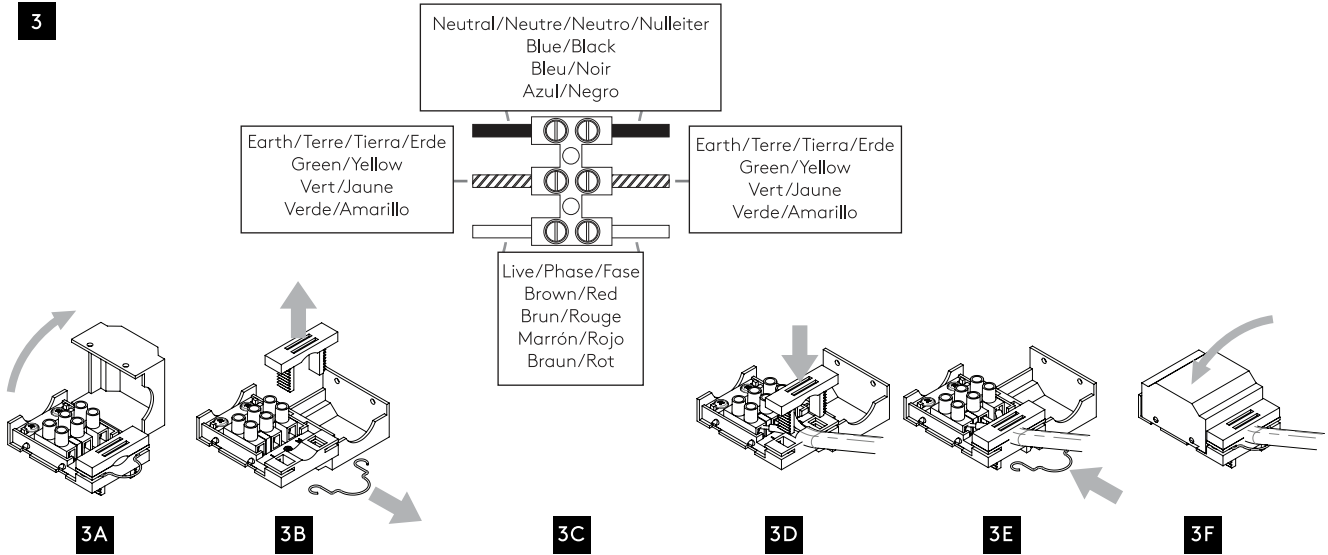

4

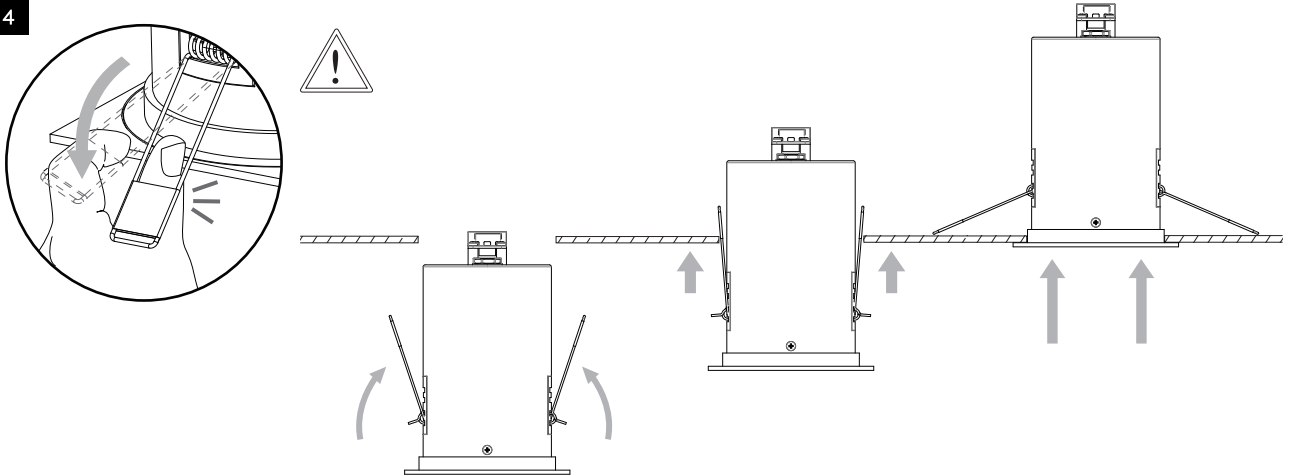

5

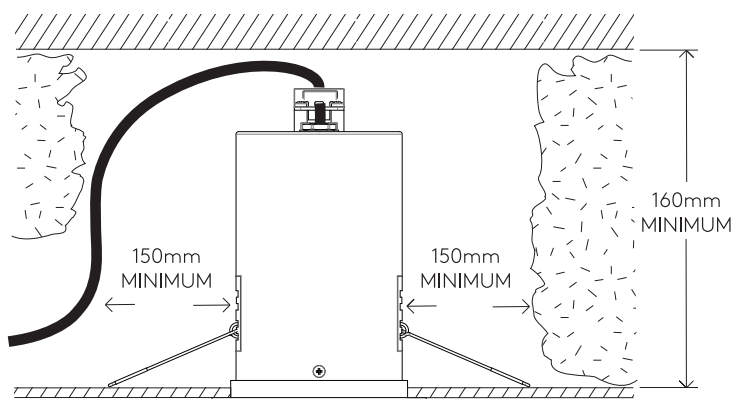

6

