

Smart KUP 115 LED GE

127610XX - 127611XX - 127612XX - 127613XX - 127614XX - 127615XX -
127616XX - 127617XX - 127618XX - 127600XX - 127601XX - 127602XX

Lamp type : LED array

1

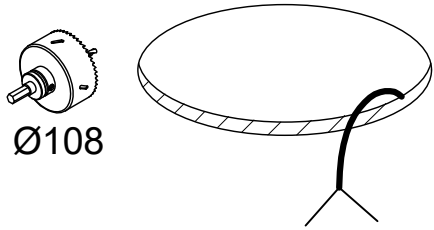

Ø108

350mA - min 29,1Vf - max 33,7Vf - 11W
500mA - min 29,9Vf - max 34,7Vf - 16,2W
700mA - min 31,0Vf - max 35,8Vf - 23,4W

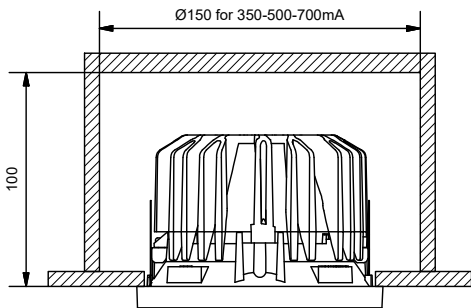

2

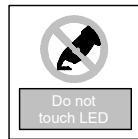
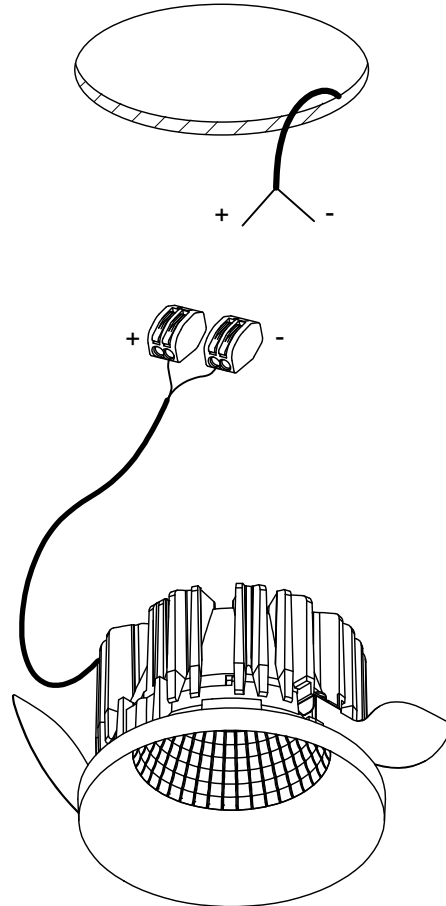

3

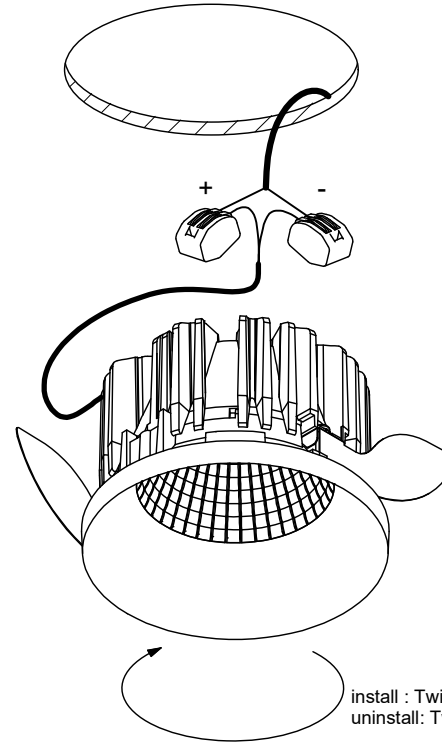

install : Twist clockwise
uninstall : Twist counterclockwise

4

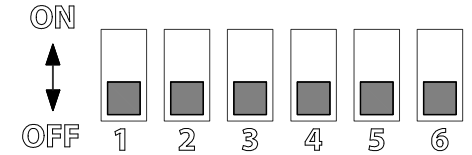
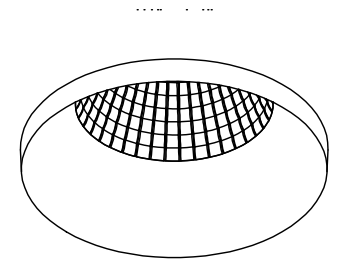

check dipswitch settings on driver



Push Dim max 5 drivers on 1 push button

The light source contained in this luminaire shall only be replaced by the manufacturer or his service agent or a similar qualified person

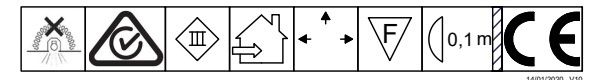

14/01/2020 V10