

**PHILIPS**



hue personal wireless lighting

PSU 40W  
EU/UK/CH/AU/NZ



User manual  
Benutzerhandbuch  
Notice d'emploi  
Manual de usuario  
Manual do usuário  
Manuale d'uso

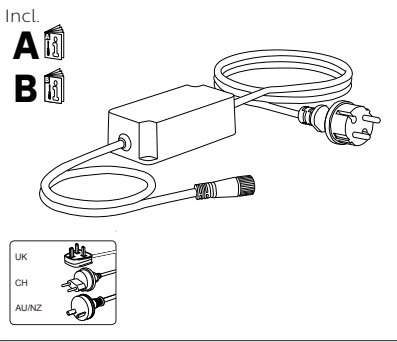

- !**
- EN** Use only with Philips Hue 24V luminaires!
  - DE** Verwenden Sie nur mit Philips Hue 24V Leuchten!
  - FR** Utiliser uniquement avec les luminaires Philips Hue 24V !
  - ES** Utilizar solamente con Philips Hue 24V luminarias!
  - PT** Utilize apenas com luminárias Philips Hue 24V !
  - IT** Utilizzare solo con apparecchi Philips Hue 24V !

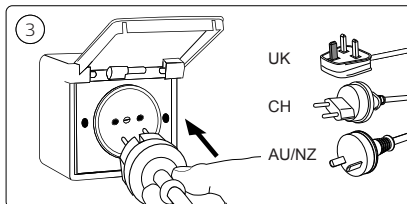
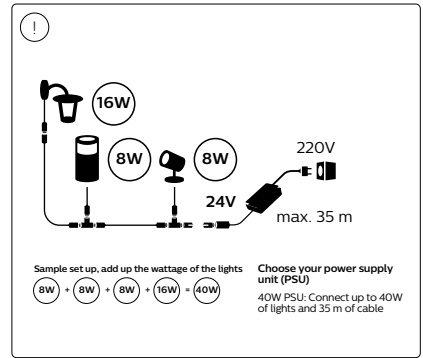
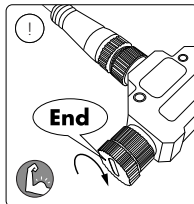
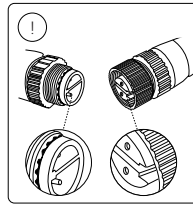
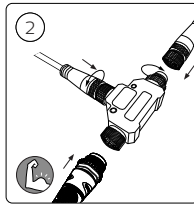
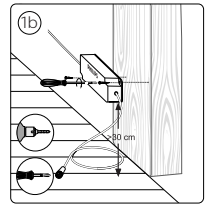
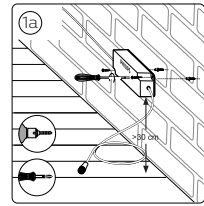
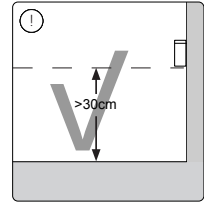
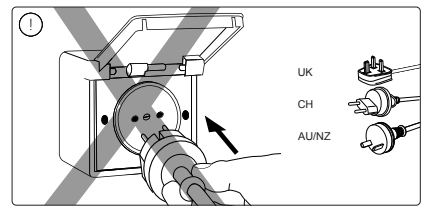

Signify  
I.B.R.S. / C.C.R.I. Numéro 10461  
5600 VB Eindhoven,  
the Netherlands  
☎00800-74454775

Signify Australia Limited  
65 Epping Road, North Ryde,  
NSW, 2113 Australia  
Toll Free number: 1300 304 404

Signify New Zealand Limited  
123 Carlton Gore Road  
Newmarket, Auckland 1023  
New Zealand  
Tel: 0800 454 448

www.philips-hue.com

4404 029 12722  
Last update: 11/2021

© 2021 Signify Holding  
All rights reserved